

工业相机接口及协议

大恒图像 彭潇

❖ 用什么？

❖ 怎么用？

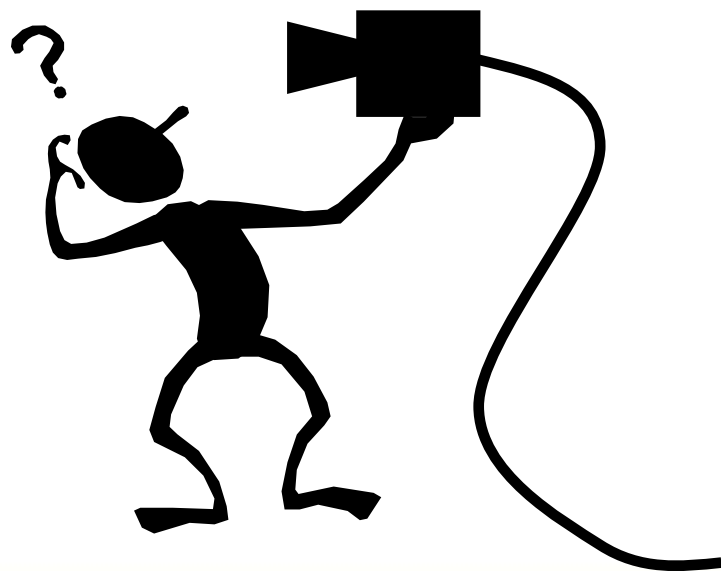



❖ 物理接口

- ◆ 接插件
- ◆ 线缆

❖ 协议标准

- ◆ 定义了数据传输格式和标准



早期的相机接口

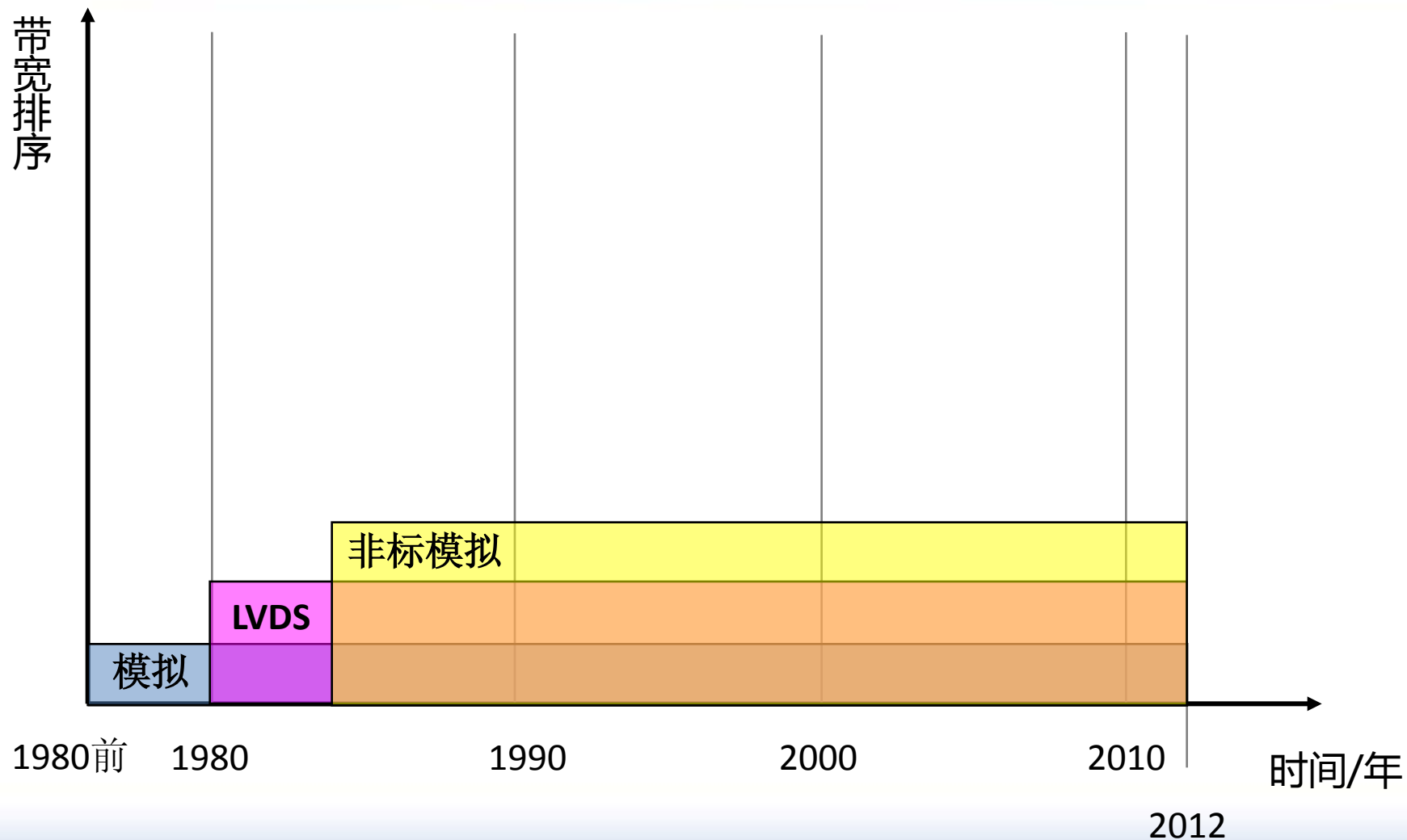

1394接口及协议

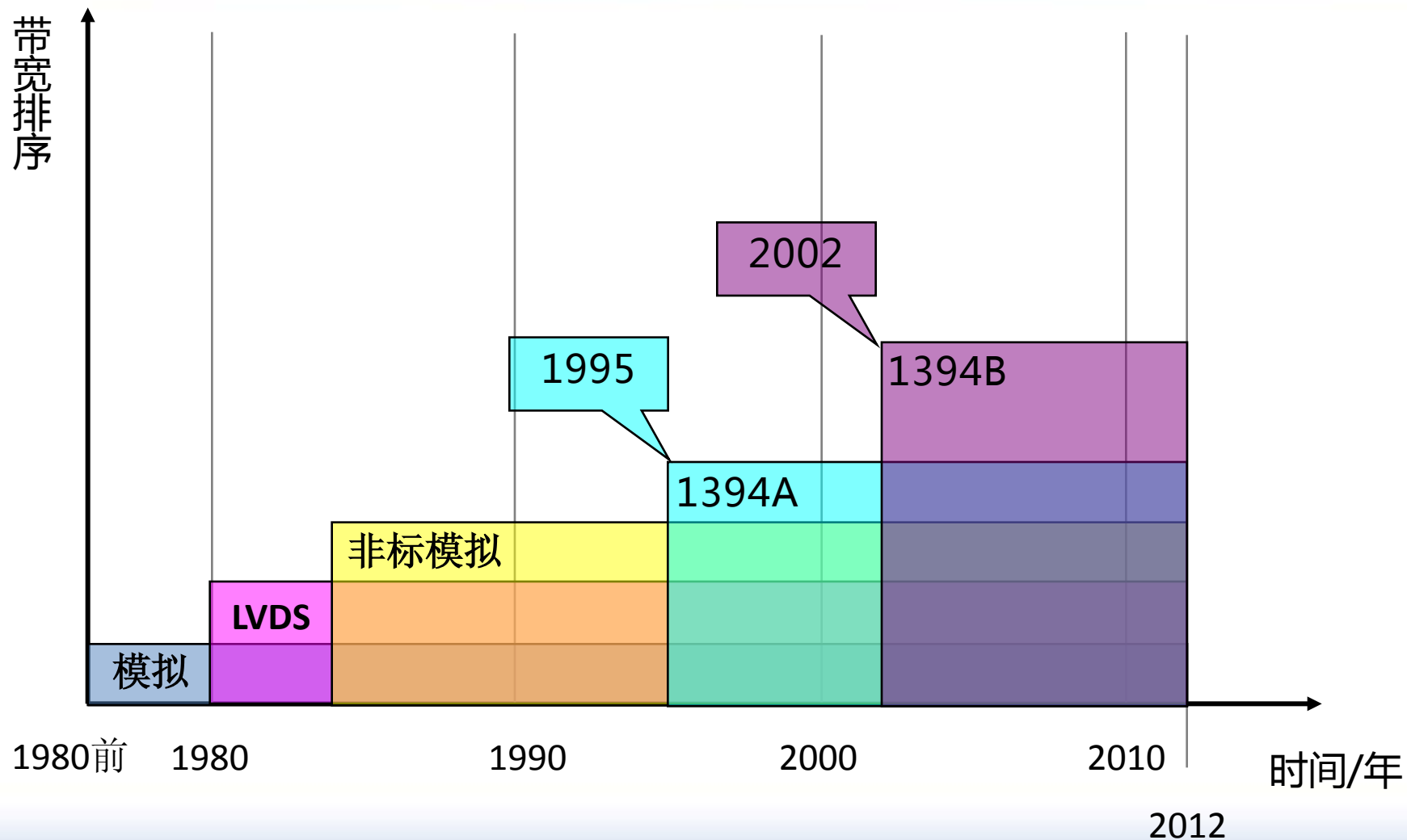

1394接口及协议

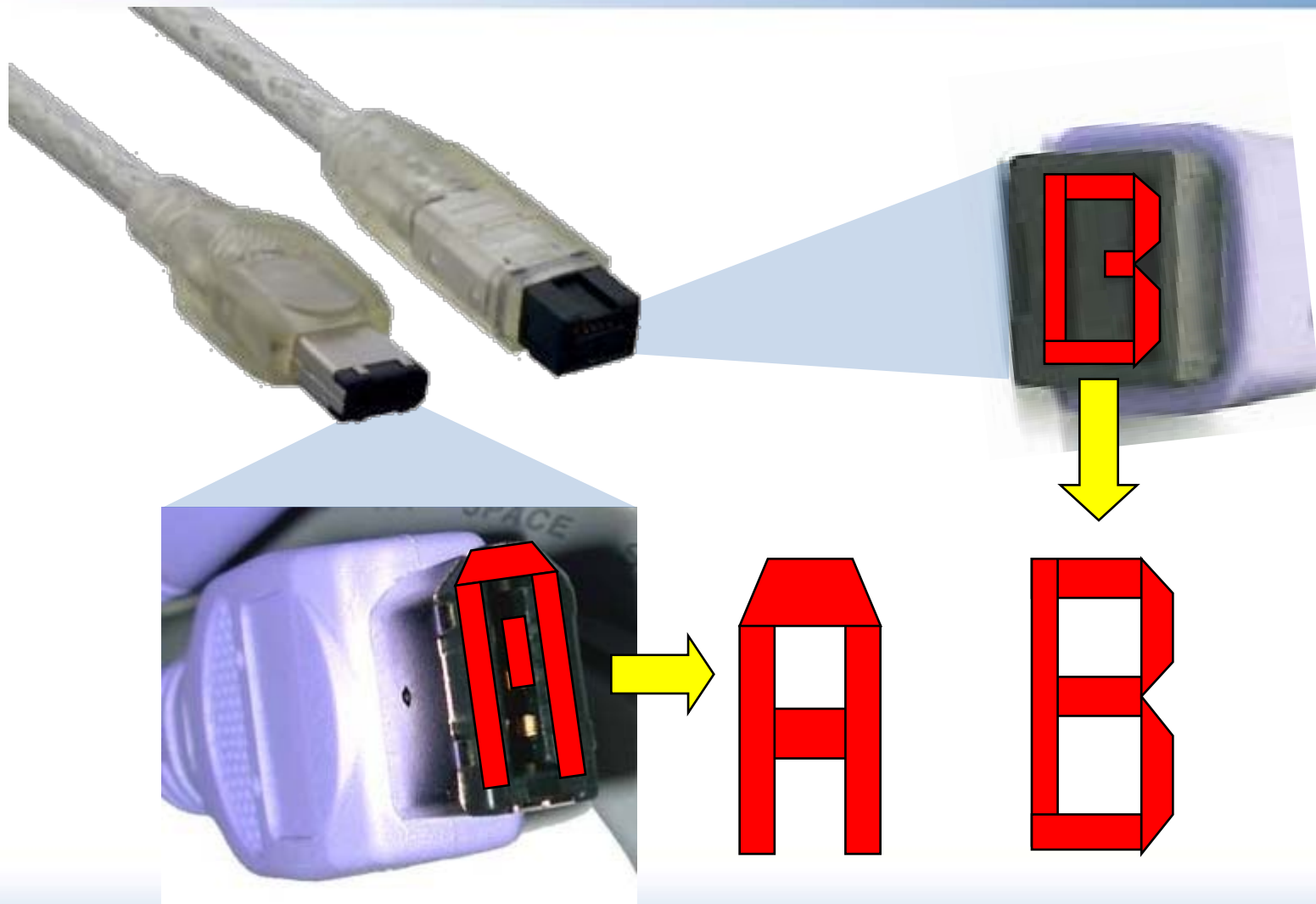



1394接口及协议

1394A

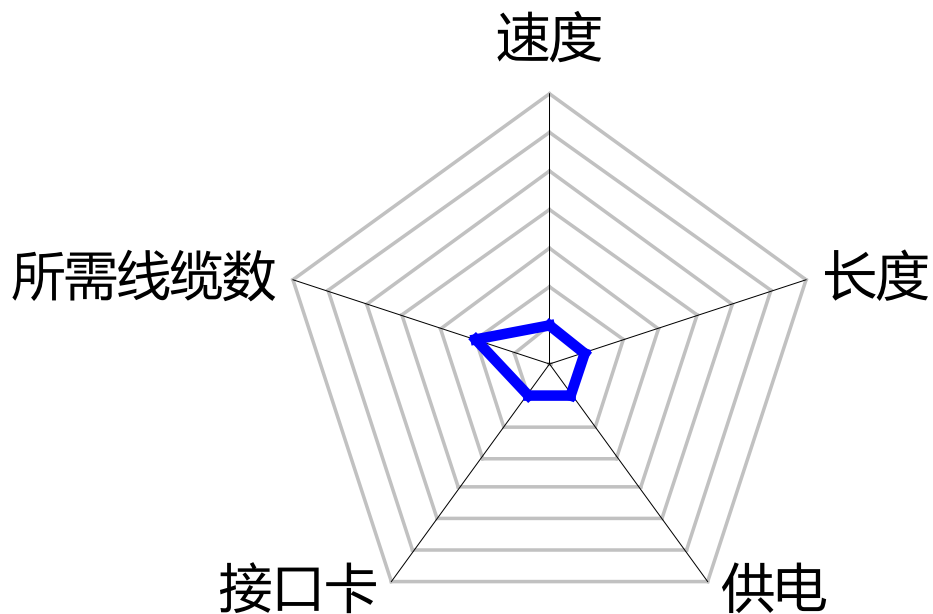

— 1394A

1394接口及协议

1394B

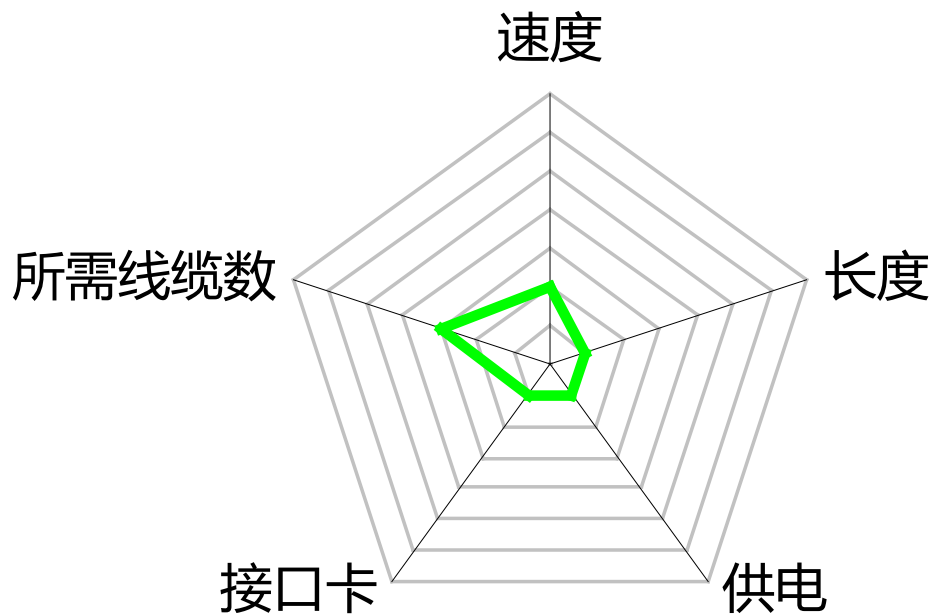

— 1394B



1394接口及协议

❖ 连接电脑采集

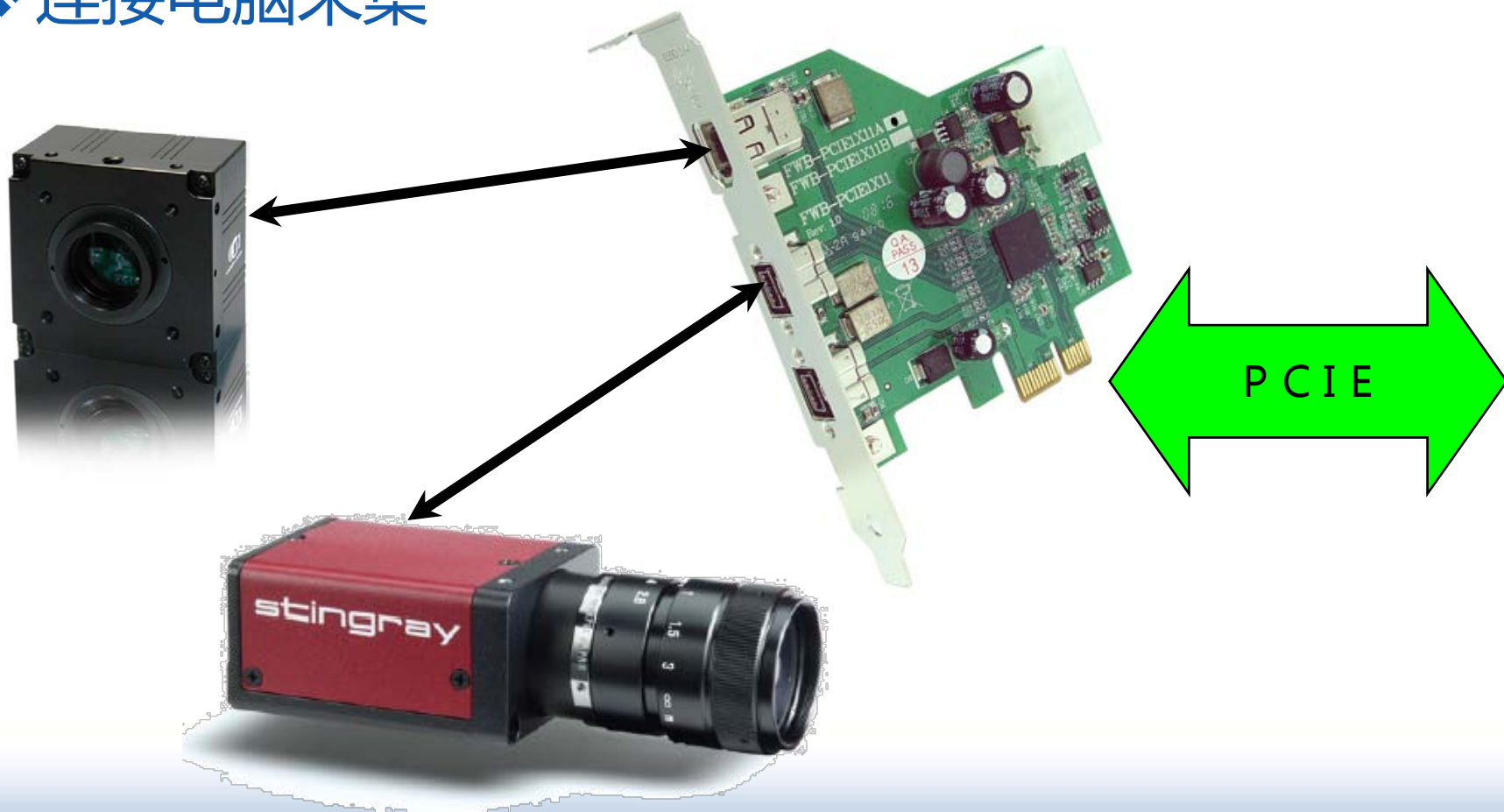



1394接口及协议

❖ DCAM (IIDC) 协议 :

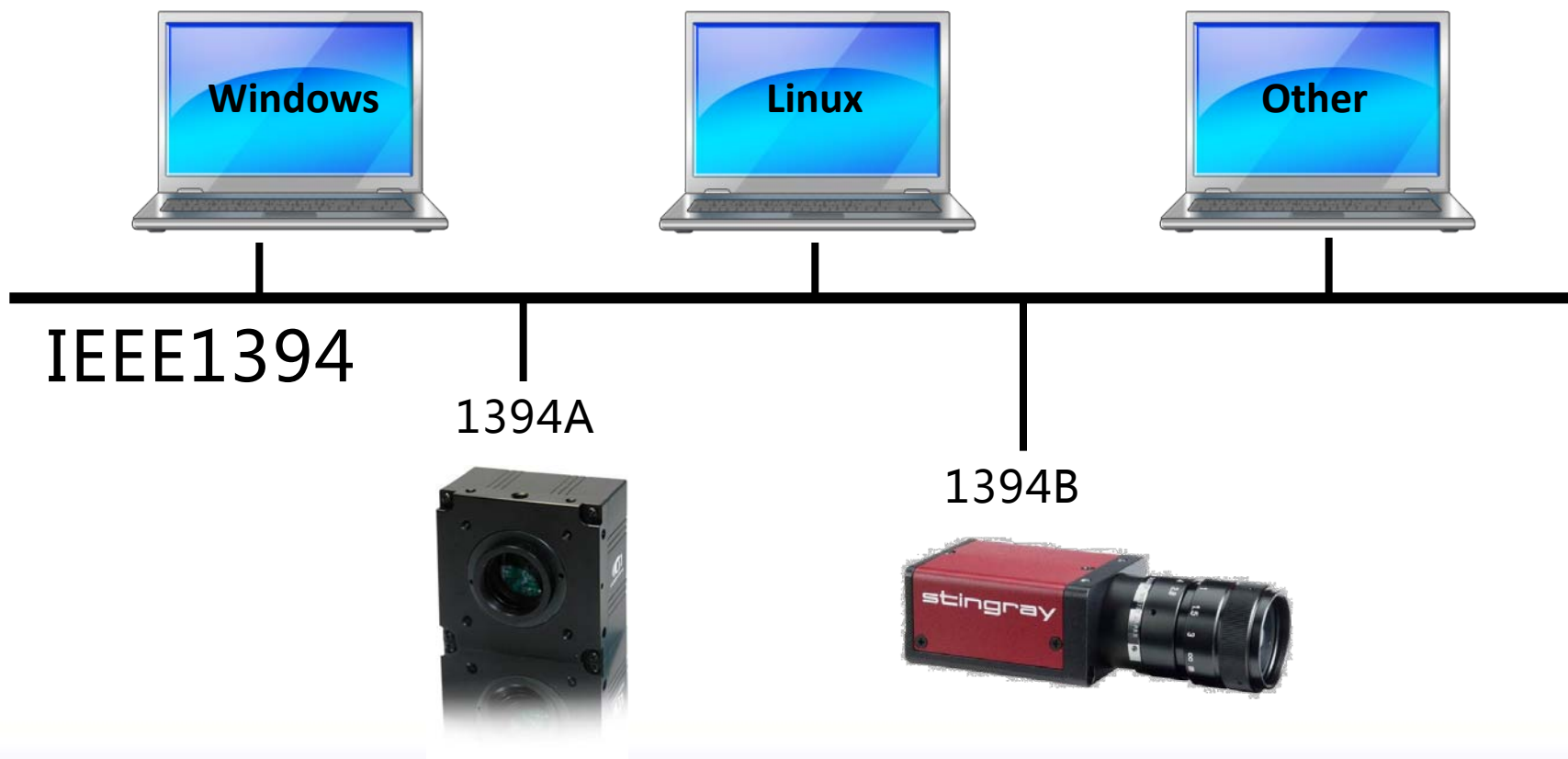



1394接口及协议

❖ IIDC2协议：

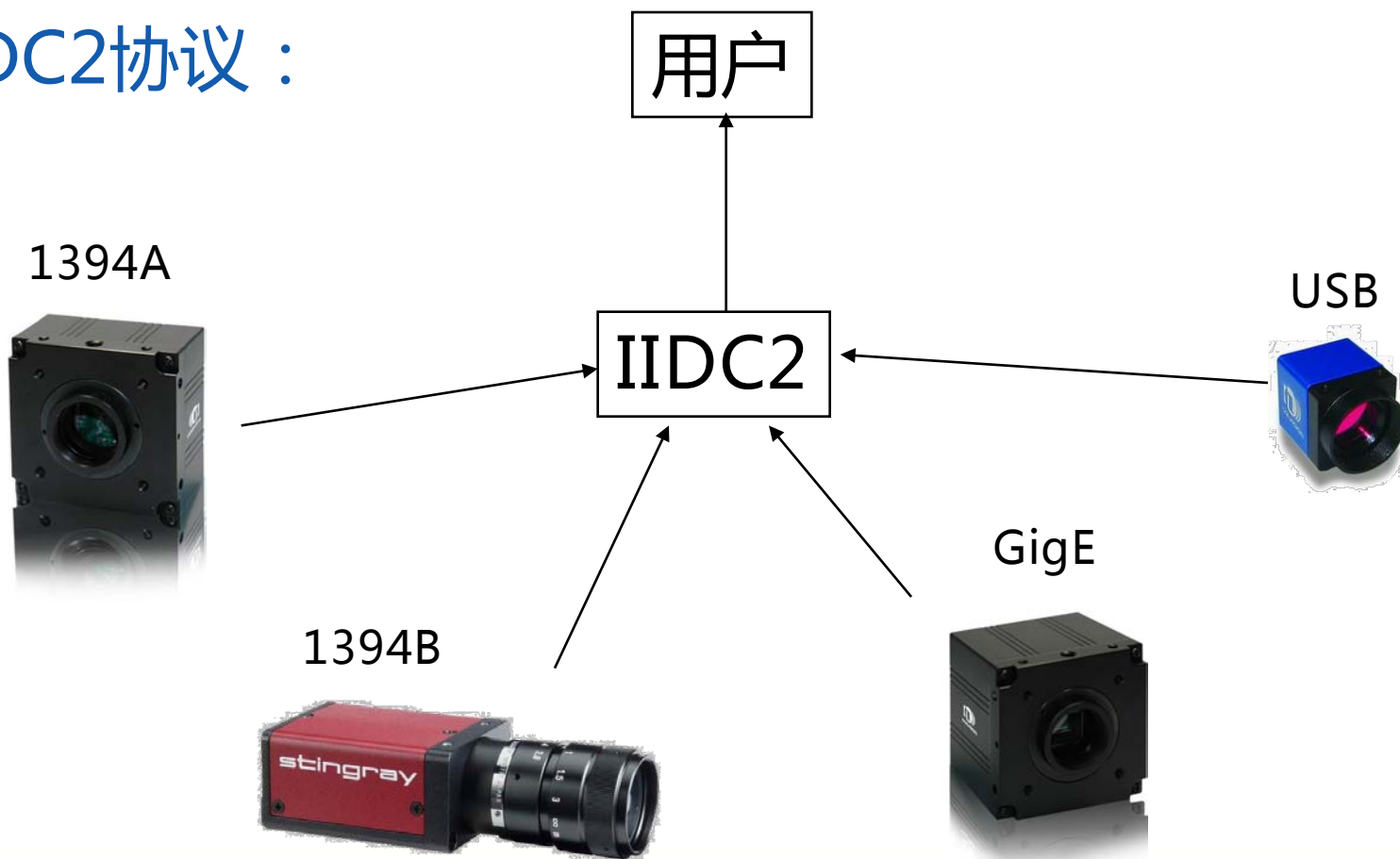

USB接口及协议

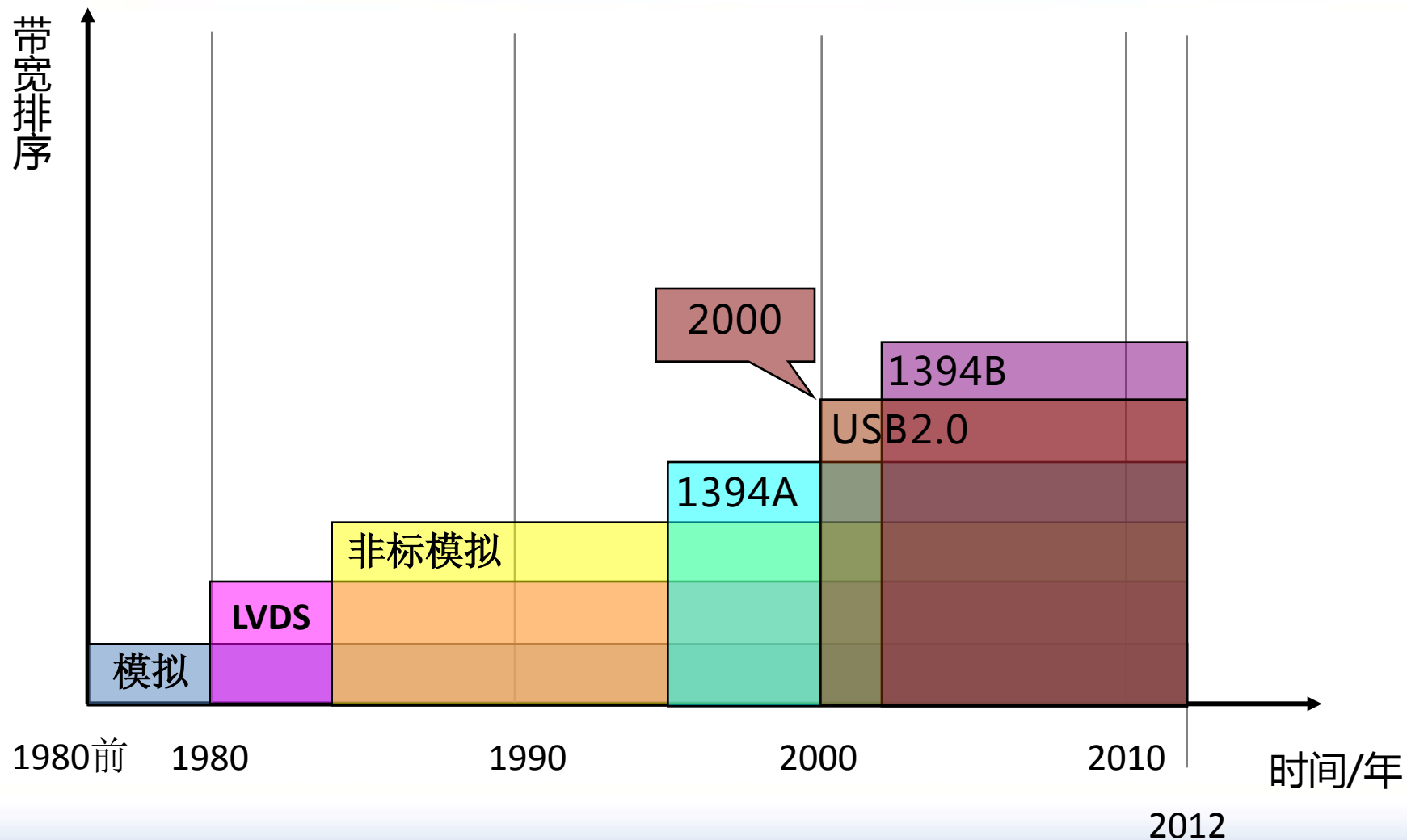



❖ 单相机连接电脑采集





❖ 多相机连接电脑采集

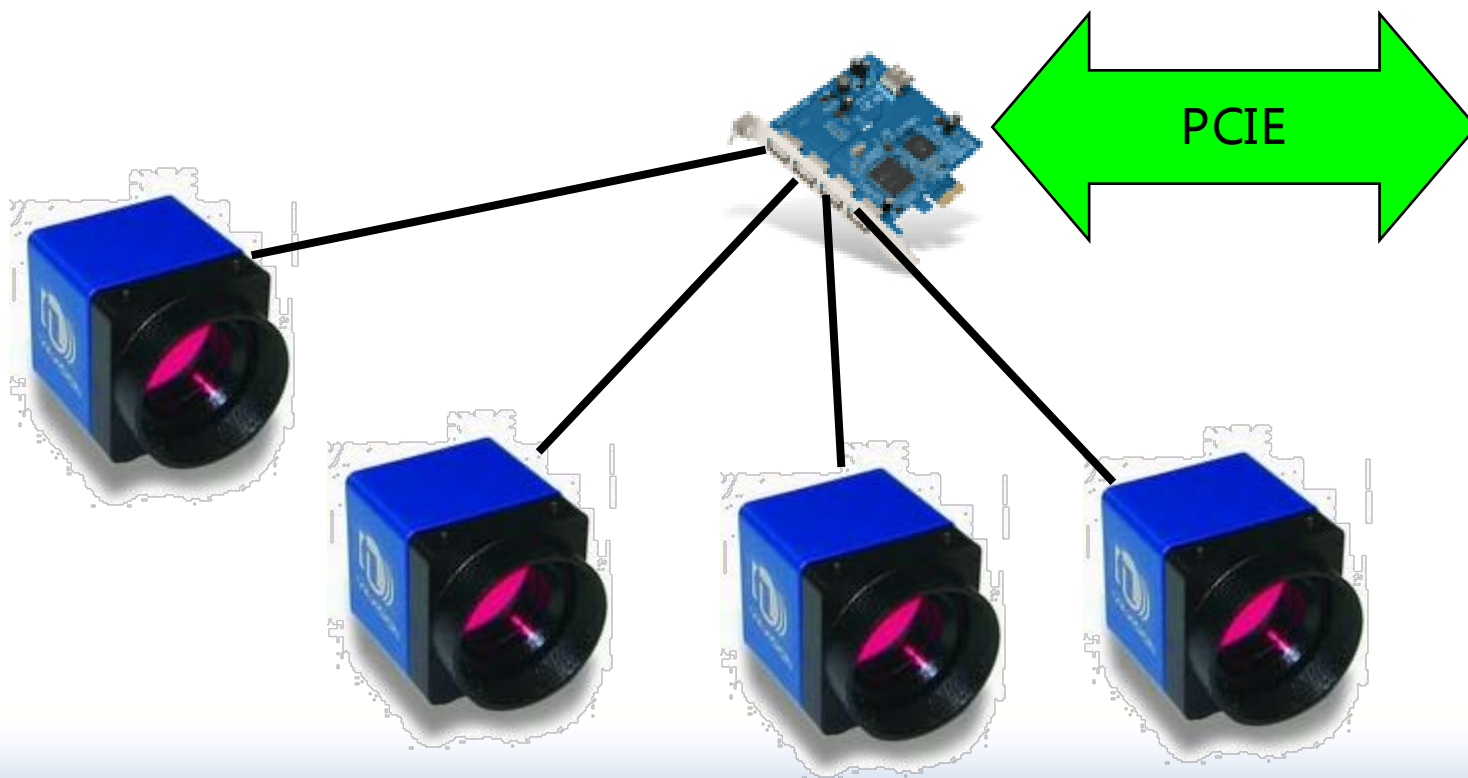

❖ USB3.0

USB发展

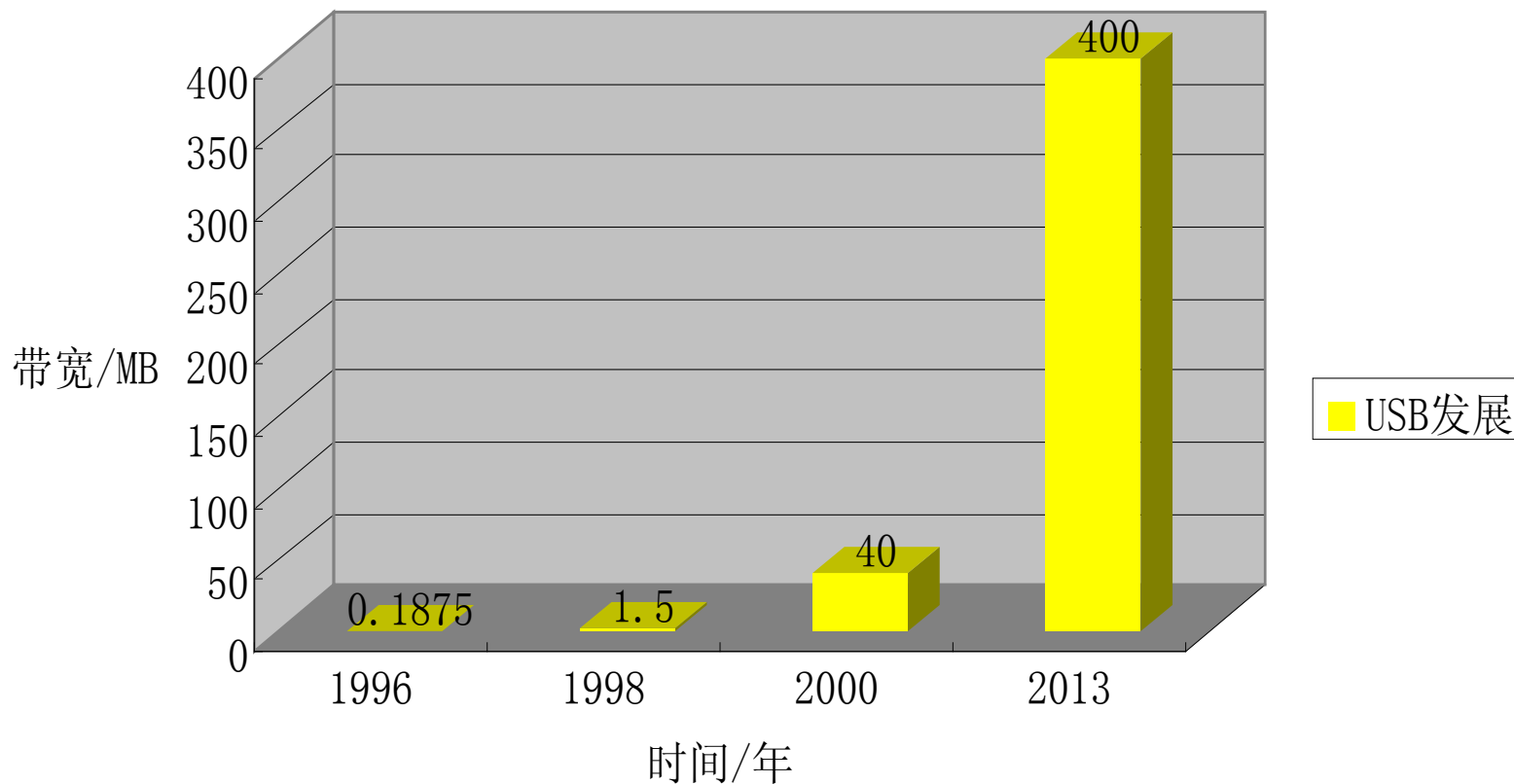



USB接口及协议

USB

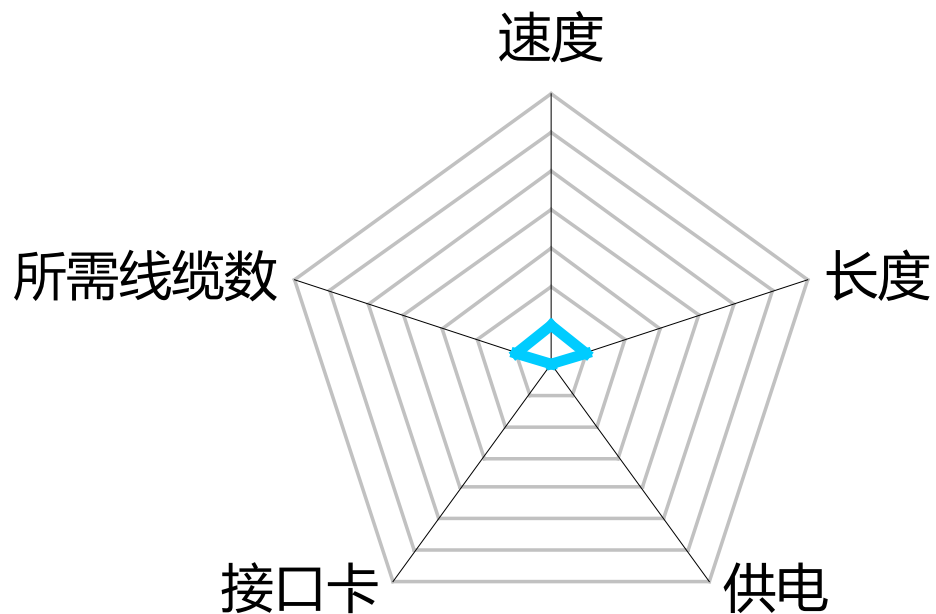

— USB

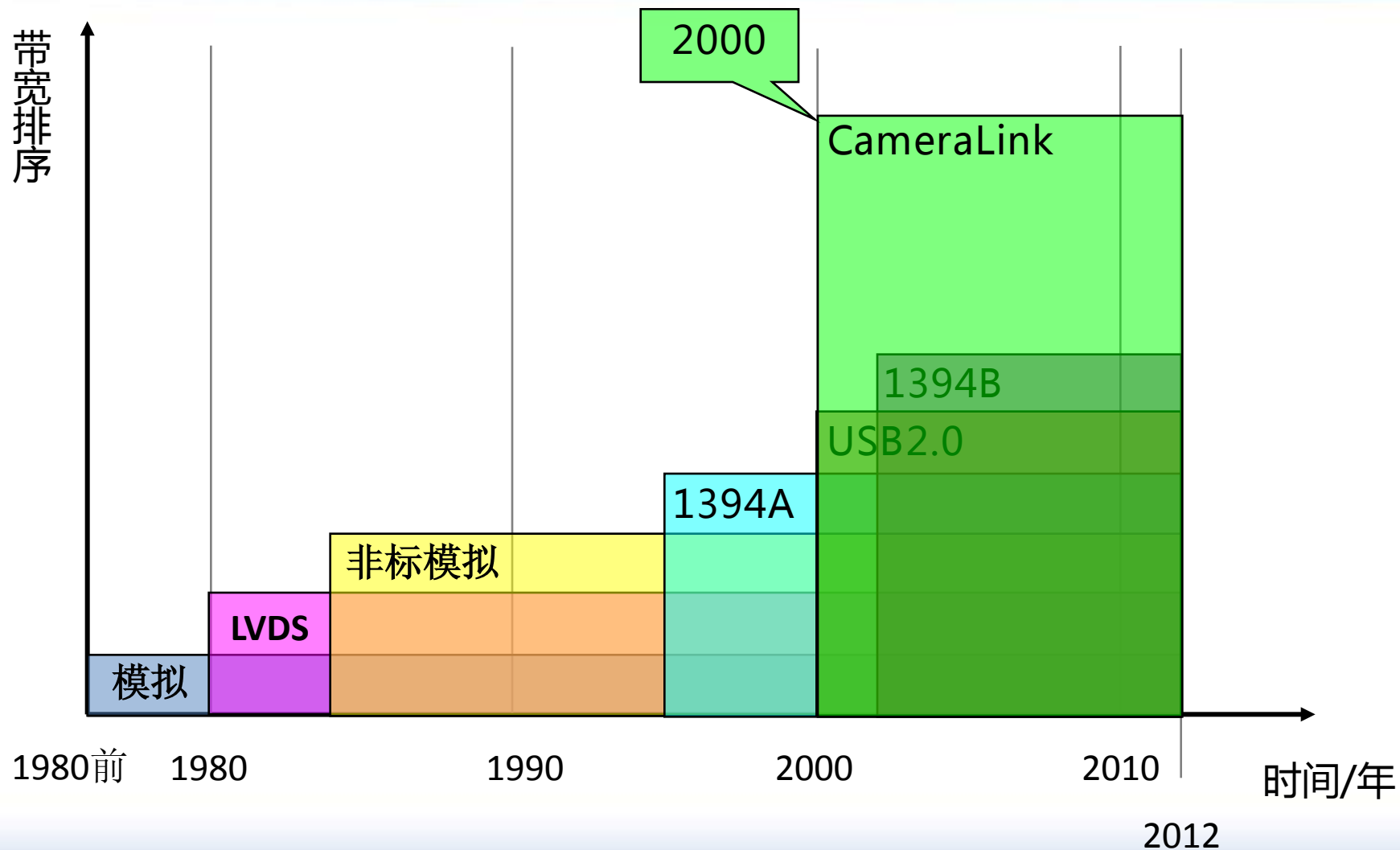

- ❖ Base接口
- ❖ Medium 接口
- ❖ Full 接口



❖ 相机连接电脑采集

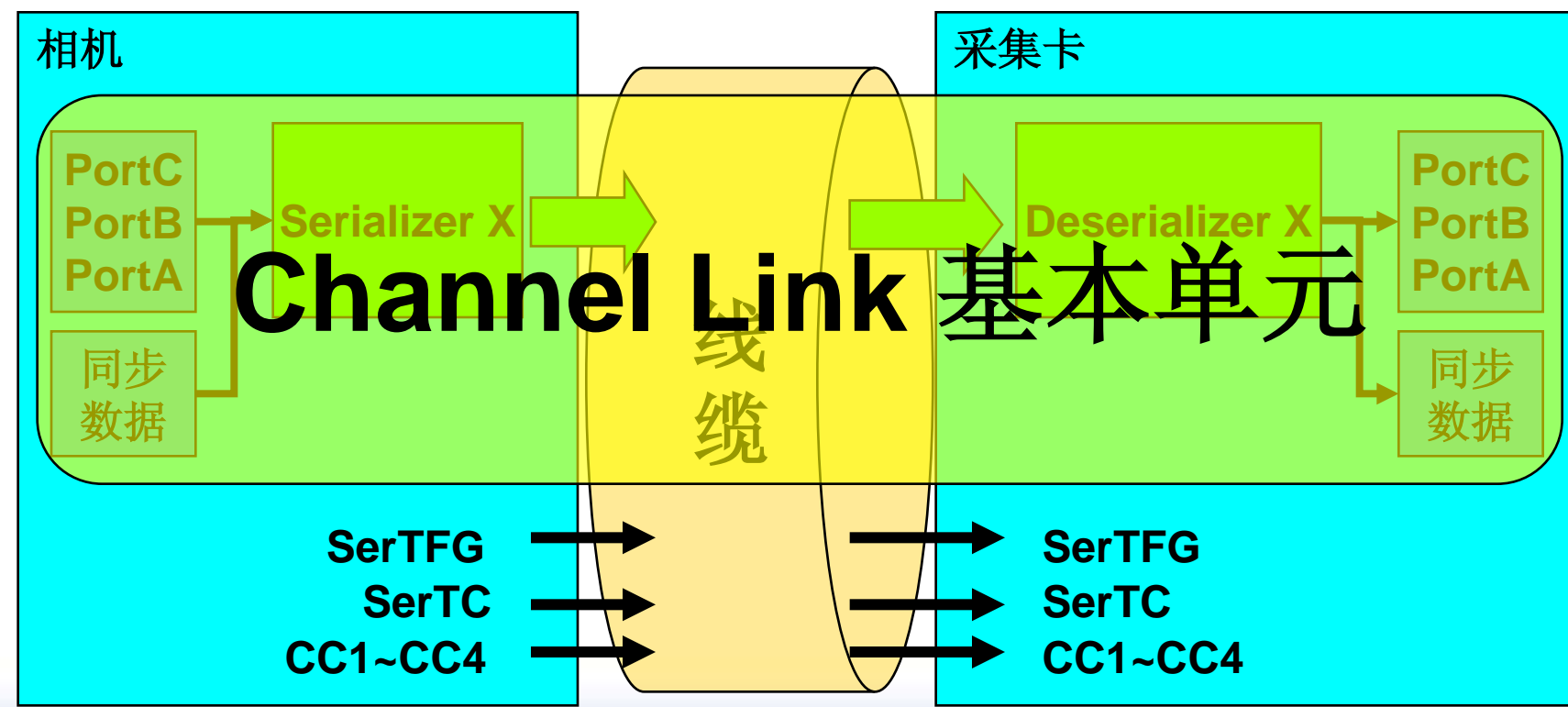

❖ Medium 接口

= Base接口 + Channel Link基本单元

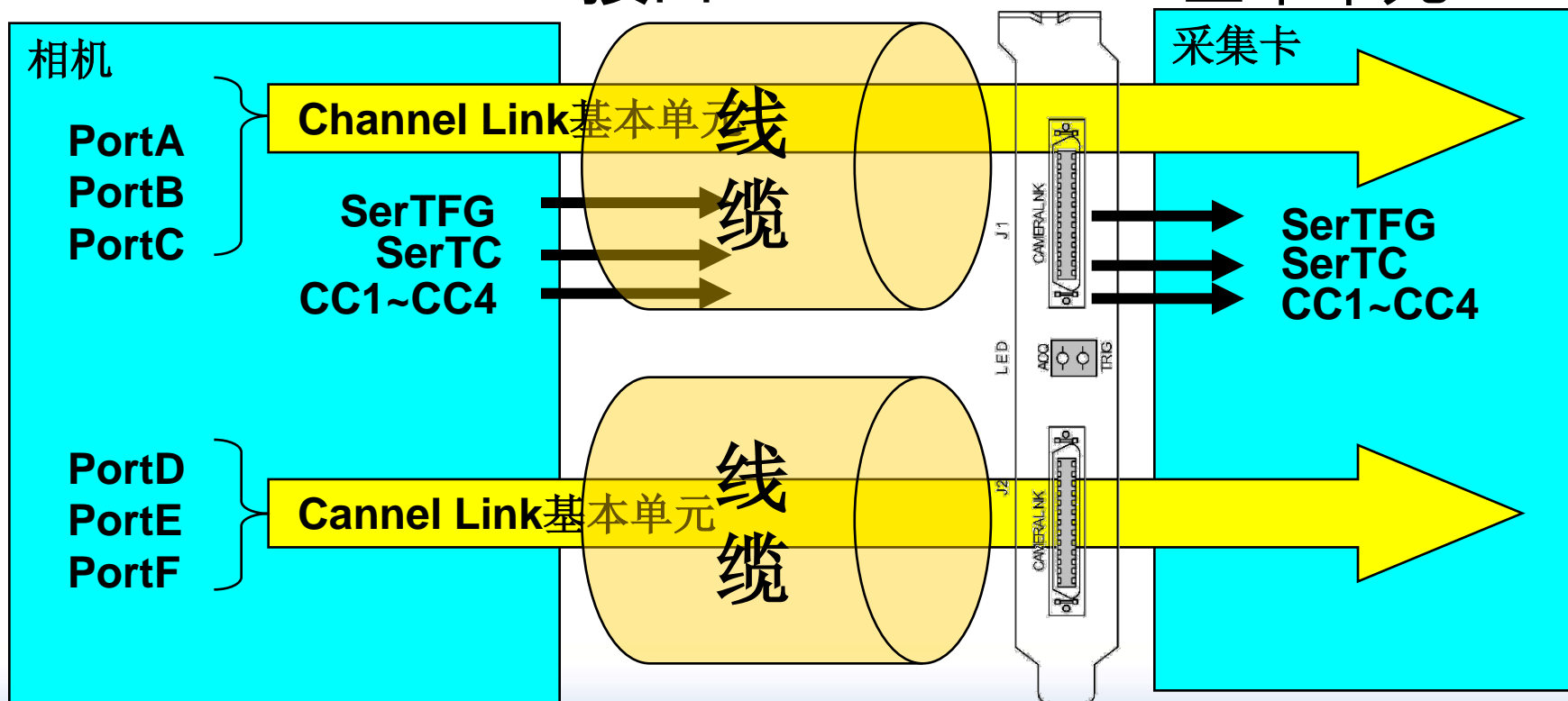

❖ Full 接口

= Base接口 + Channel Link基本单元 × 2

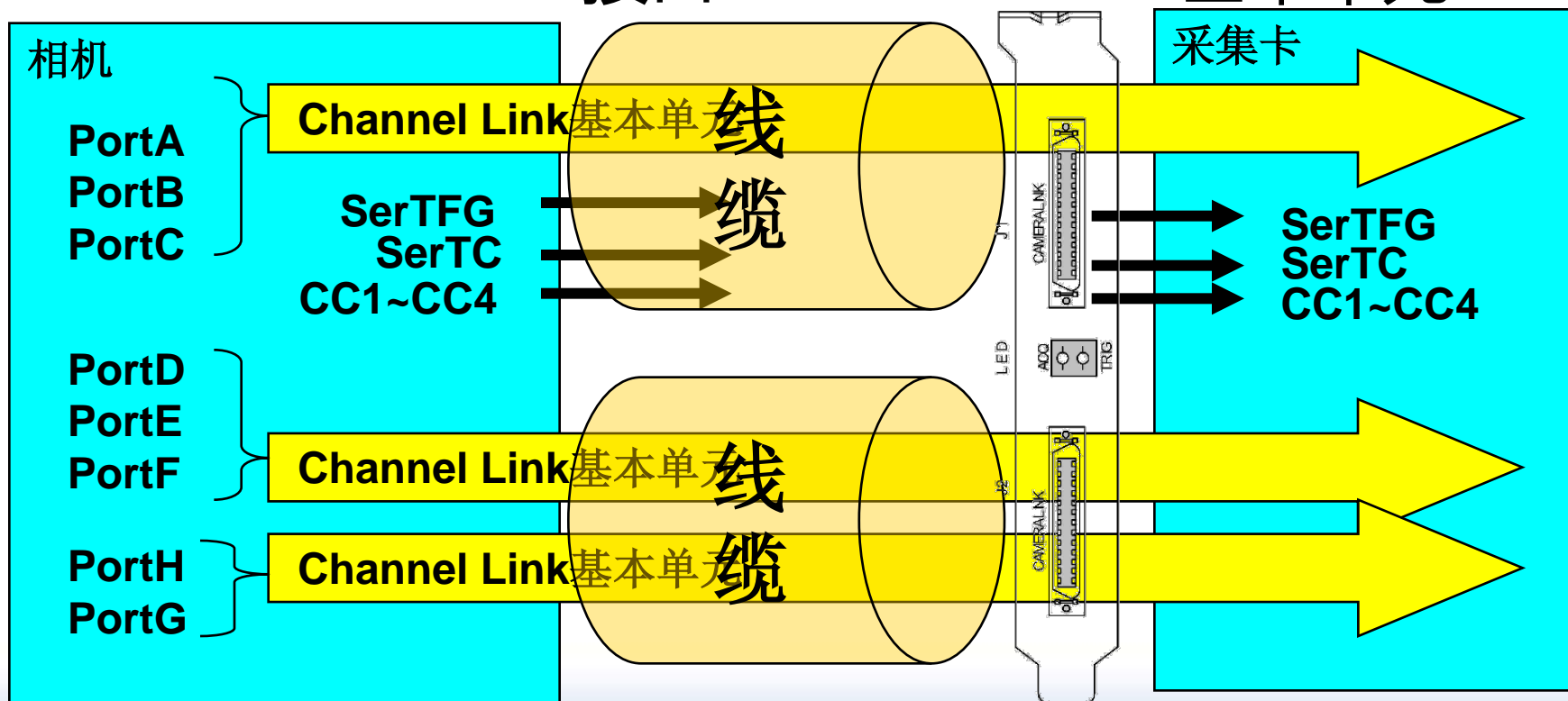



CameraLink接口和协议

CameraLink

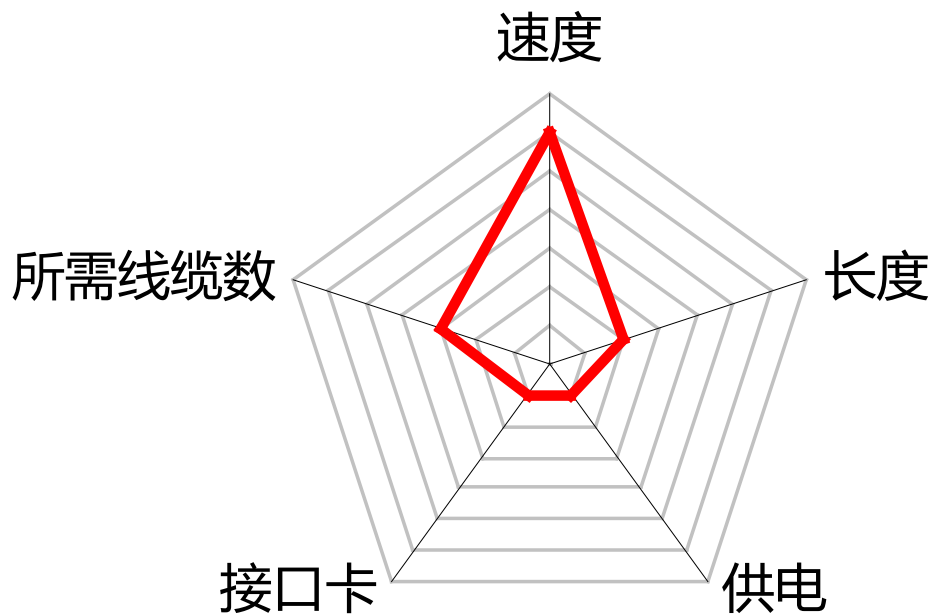

— CameraLink

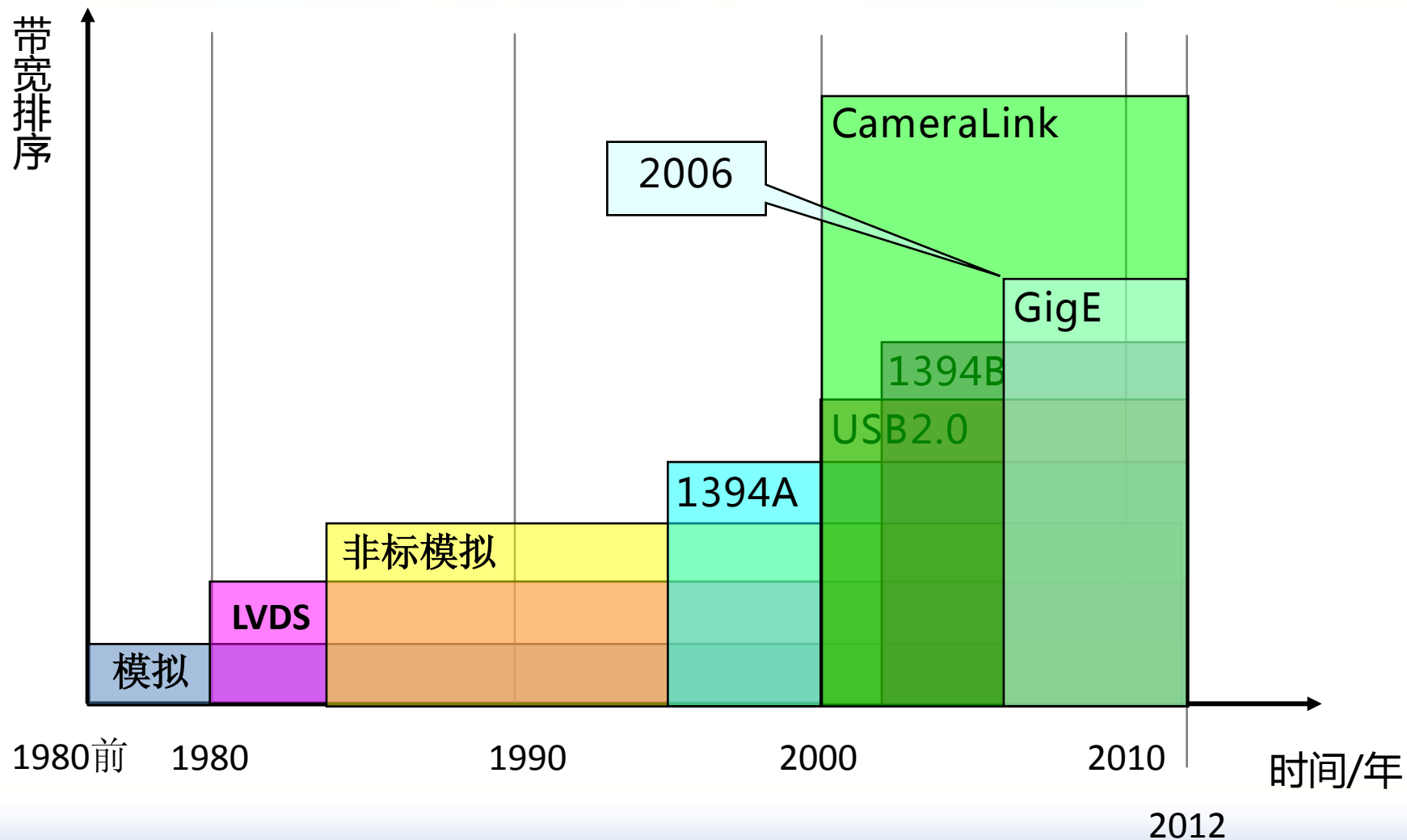



GigE接口及协议

❖ 相机连接电脑采集

- ◆ 单个网口使用与普通千兆网相机相同
- ◆ 当双网口同时使用时需要做聚合

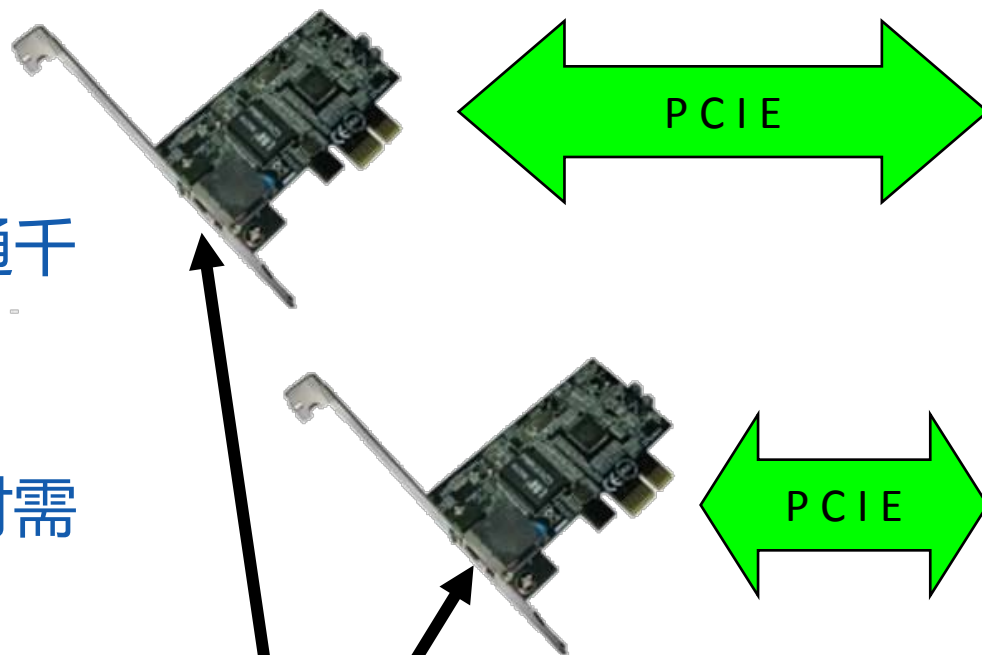



GigE接口和协议

Gige

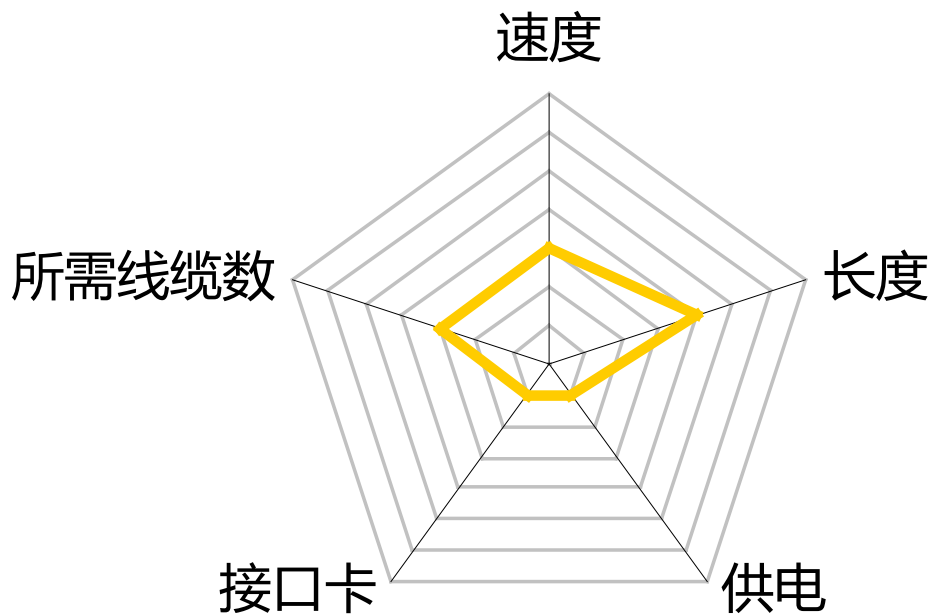

— Gige

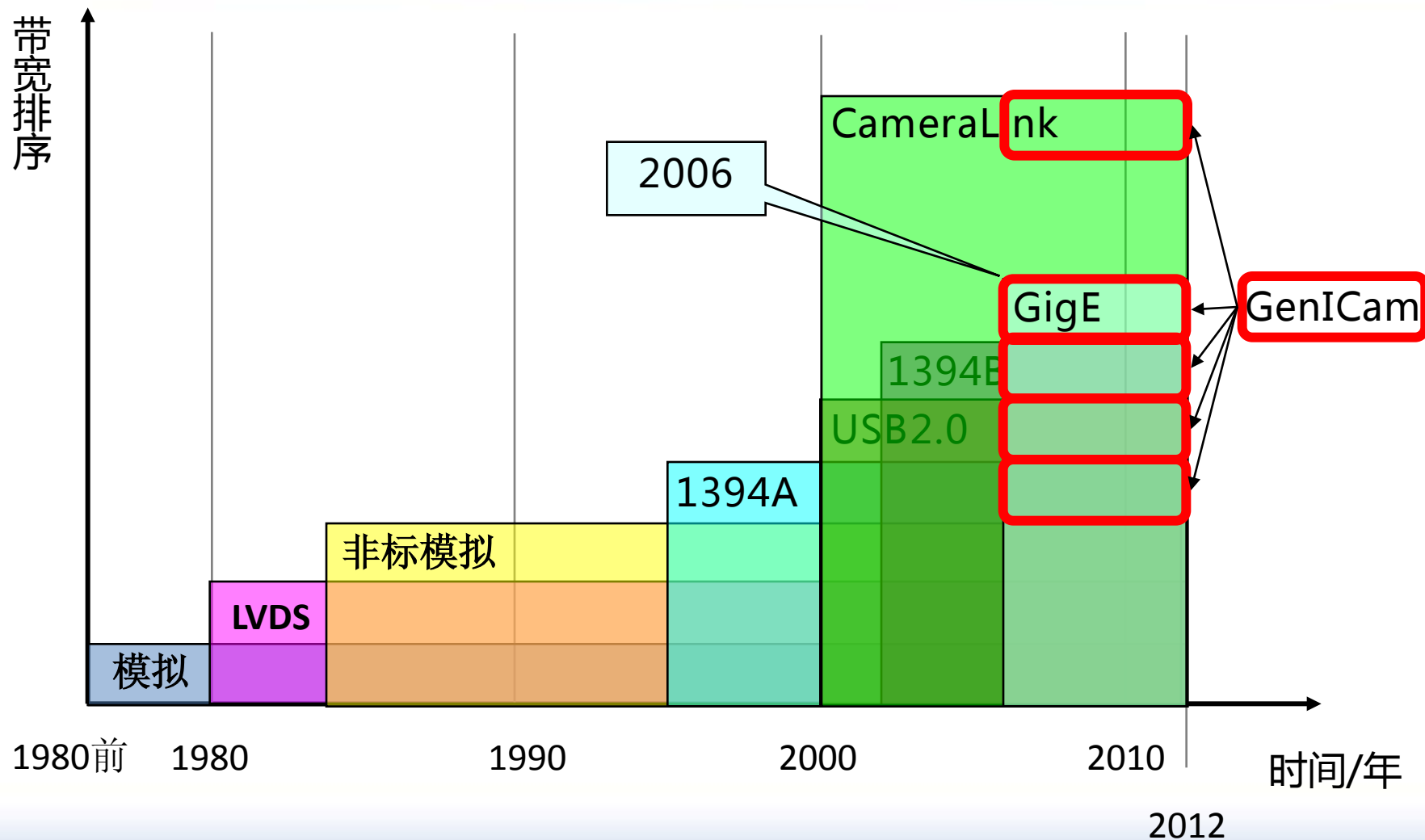

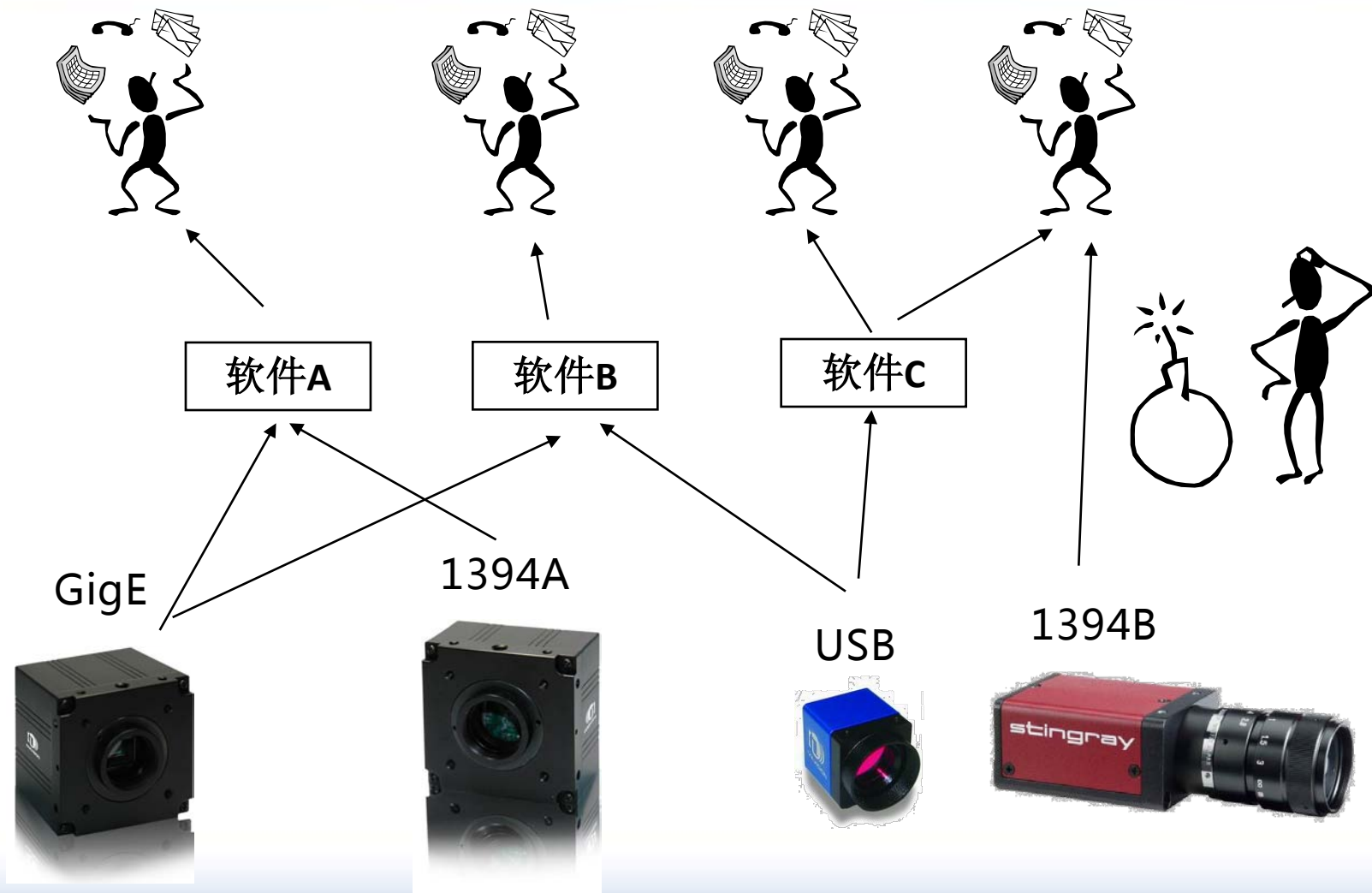

GenICam

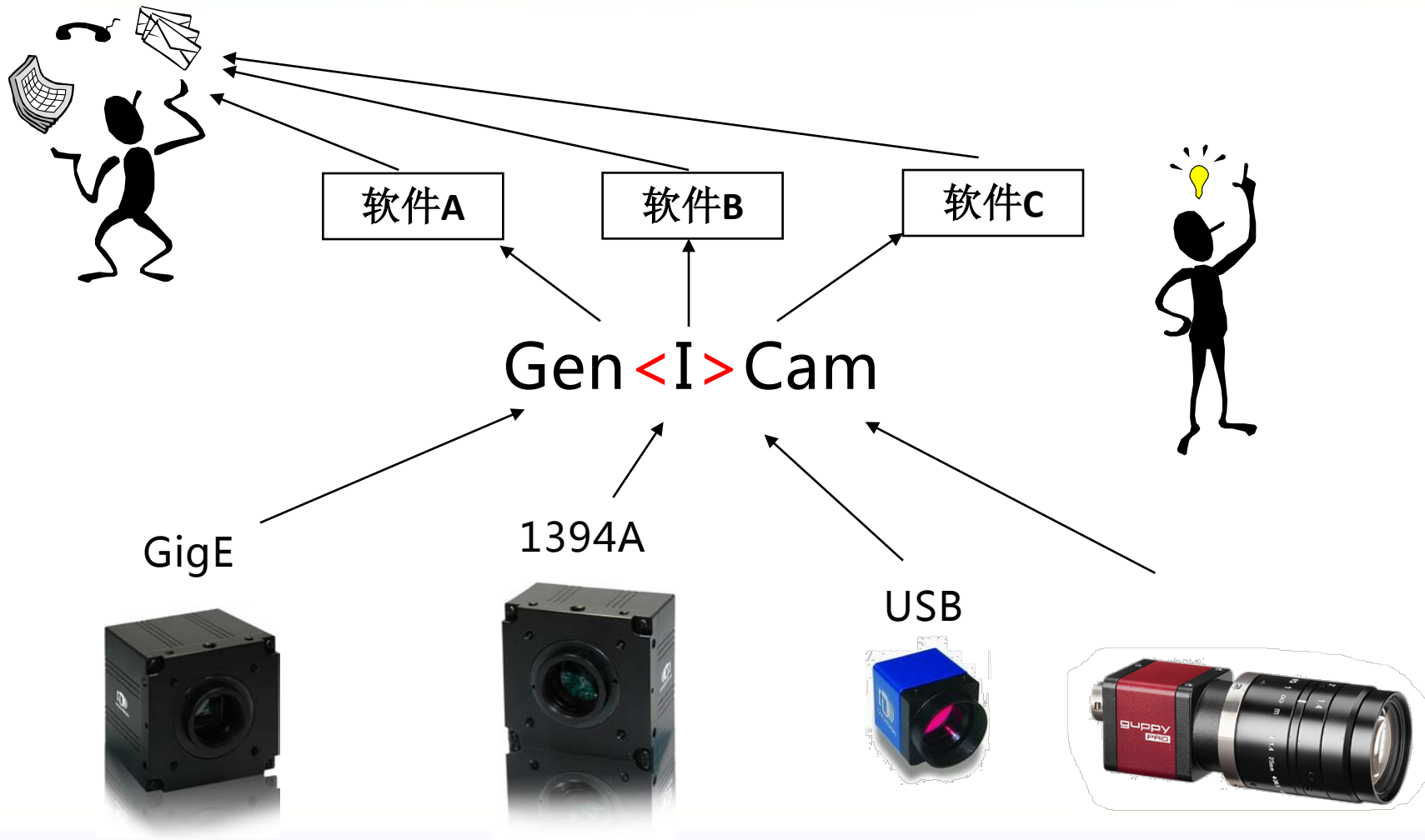

CameraLink HS

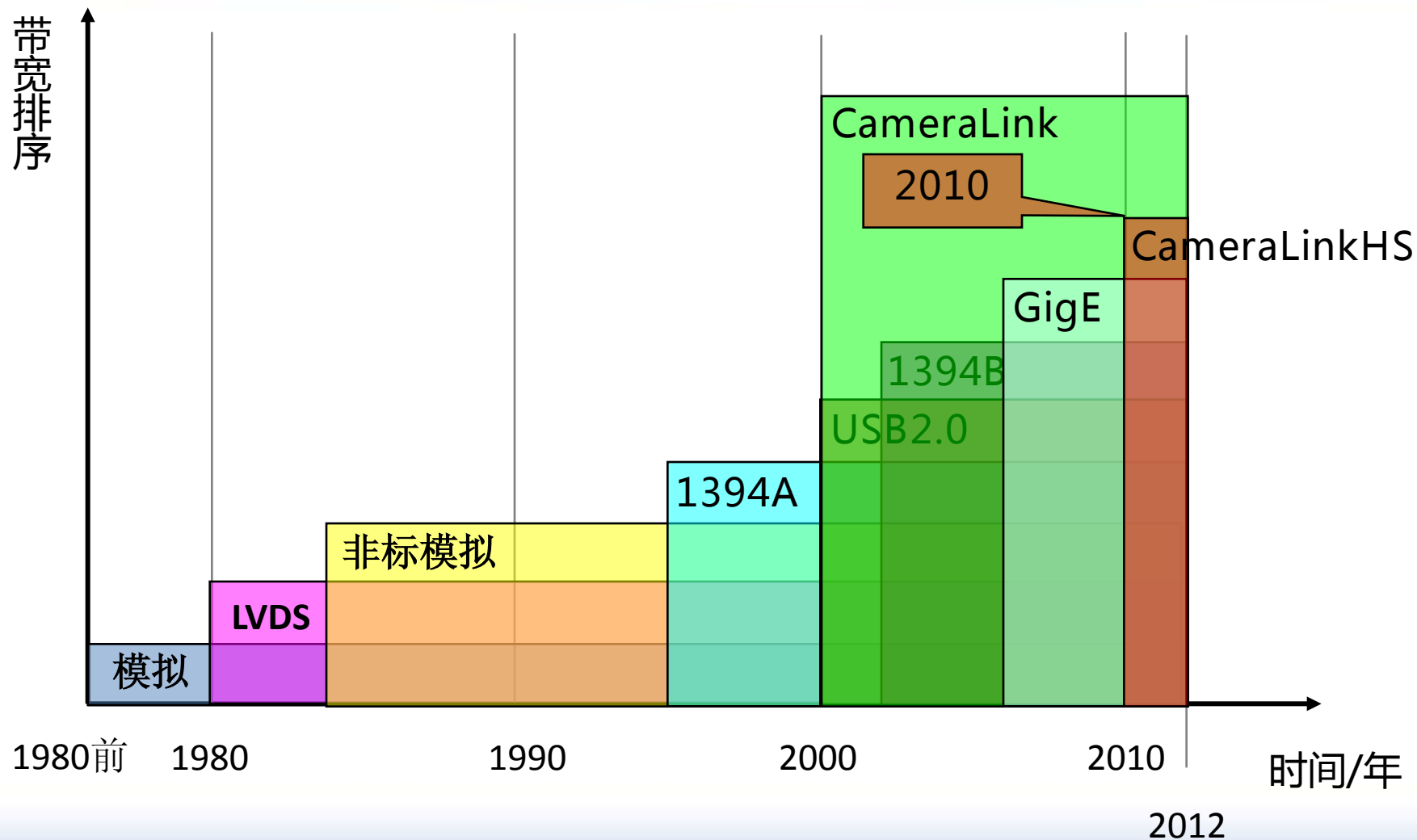



❖ 连接电脑采集





CameraLinkHS接口和协议

CameraLinkHS

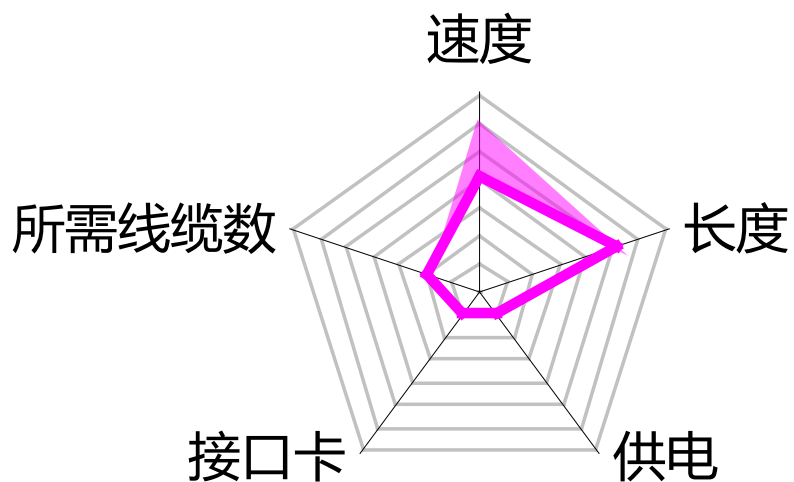

— CameraLinkHS

CoaXPress接口和协议

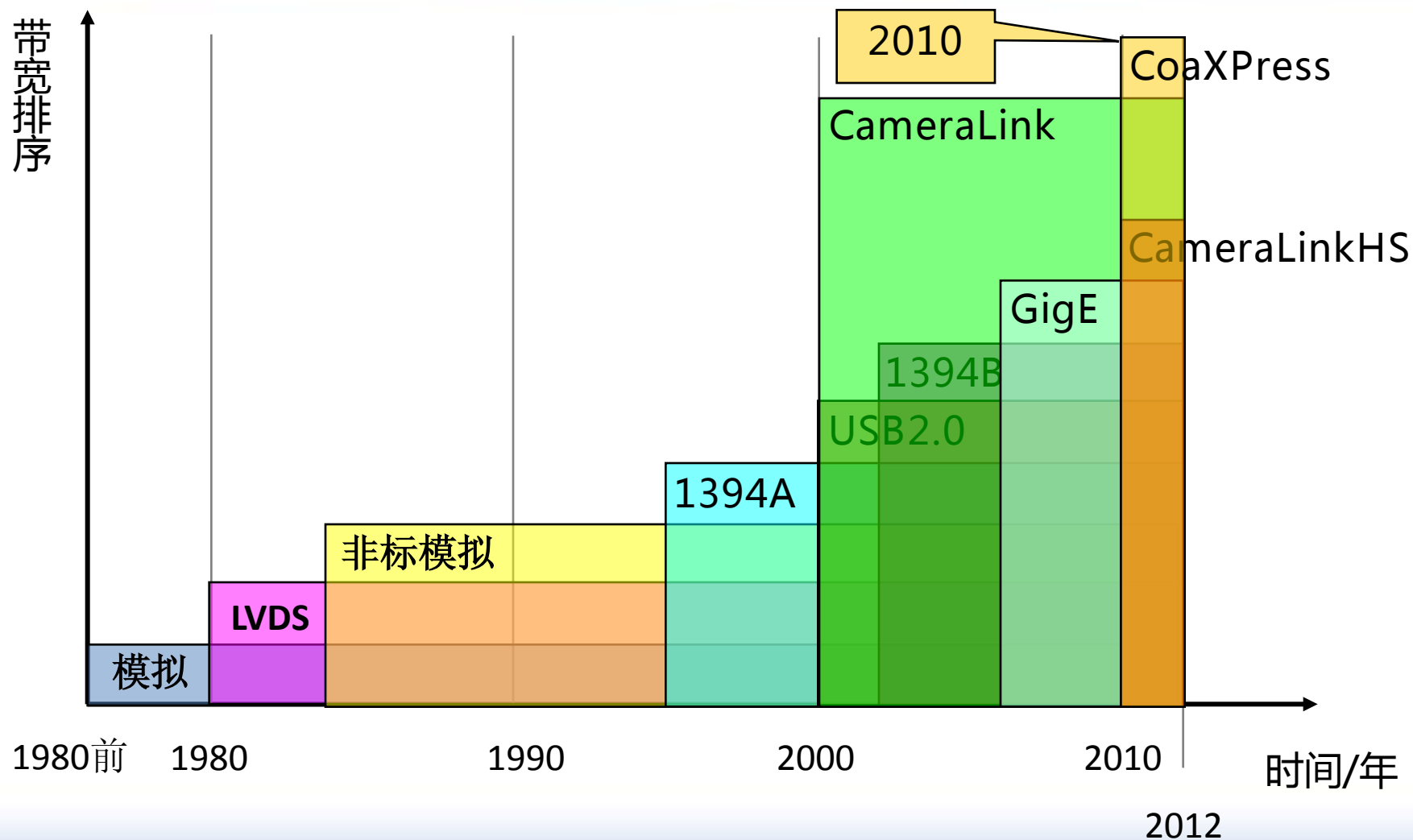



❖ 连接电脑采集



CoaXPress

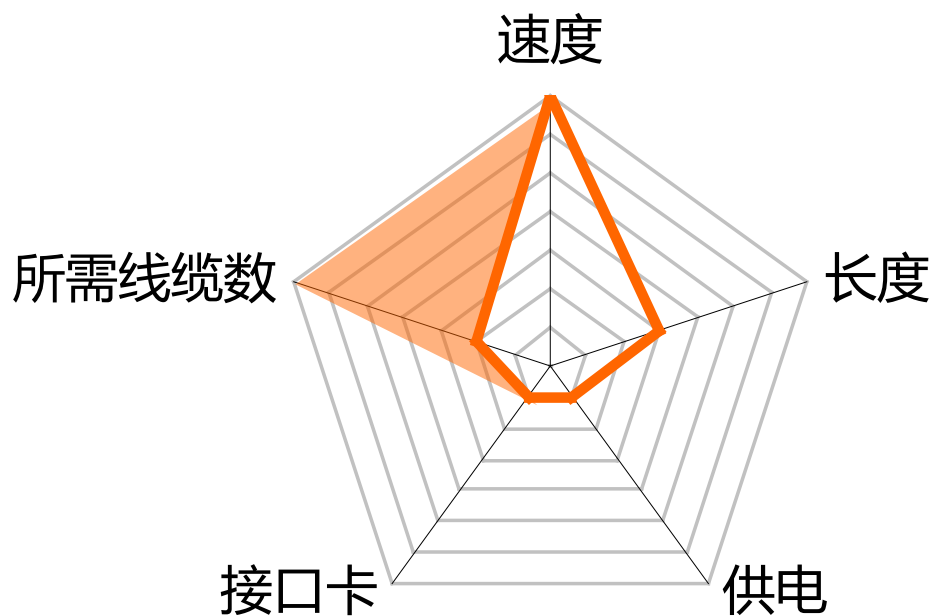

— CoaXPress



❖ 常用接口对比

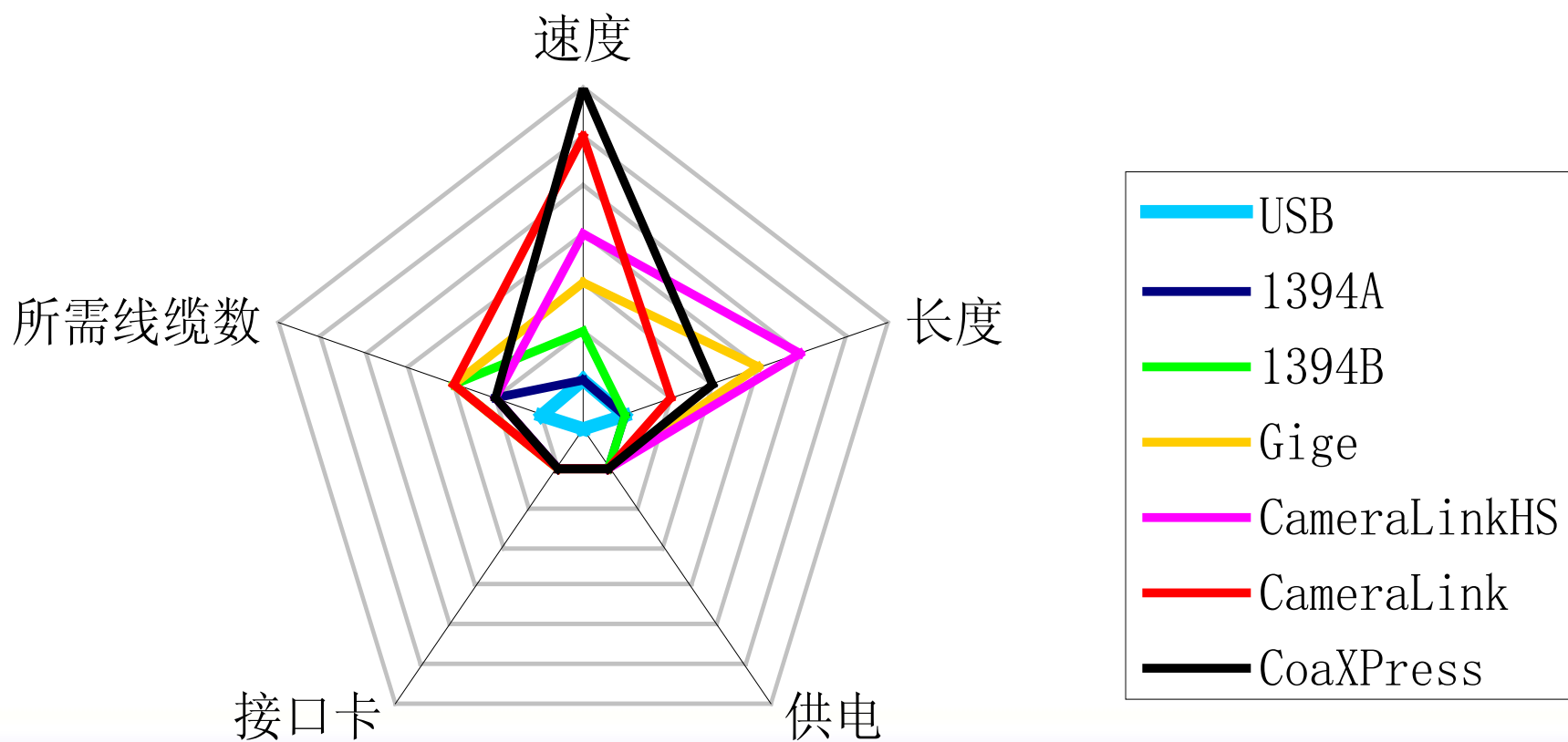



工业相机接口及协议

❖ 展位：

中国大恒（集团）有限公司
北京图像视觉技术分公司

谢谢